



Le elettropompe serie NR, NR4 rispettano il Regolamento Europeo N. 547/2012.

Materiali

Componenti	Materiali
Corpo pompa	Ghisa GJL 200 EN 1561
Raccordo	
Girante	Ghisa GJL 200 EN 1561 (Ottone P-Cu Zn 40 Pb 2 UNI 5705 per NR-NR4 30,40,50)
Albero	Acciaio al nichel-cromo AISI 303 per pompe fino a 1,1 kW Acciaio al cromo AISI 430 per pompe da 1,5 a 18,5 kW
Tenuta meccanica	Carbone - ceramica - NBR
Controflange	Acciaio Fe 430B UNI 7070

Esecuzioni speciali a richiesta

- Altre tensioni. - Frequenza 60 Hz. - Protezione IP 55. - Tenuta meccanica speciale.
- Per liquido o ambiente con temperatura più alta o più bassa.
- Motore predisposto per funzionamento con inverter fino a 0,55 kW NR4 e 0,75 per NR.

Esecuzione

Elettropompe centrifughe, monogiranti, monoblocco con accoppiamento diretto motore-pompa e albero unico. Corpo pompa con bocche di aspirazione e di mandata con lo stesso diametro e disposte sullo stesso asse (esecuzione "in-line").

Bocche: Flange PN 10, EN 1092-2.

Controflange (a richiesta)

Grandezza	Flange
NR, NR4 32,40,50,65	Flange filettate PN 16, EN 1092-1
NR4 100, NR4 125	Flange da saldare a sovrapposizione PN 10, EN 1092-1

Versione con inverter I-MAT (a richiesta)

Impieghi

Per liquidi puliti senza parti abrasive, non aggressivi per i materiali della pompa (con parti solide fino a 0,2% max).
Per impianti di riscaldamento, condizionamento, raffreddamento e circolazione.
Per applicazioni civili e industriali.
Quando è richiesto un funzionamento con rumorosità ridotta (n = 1450 1/min).

Limiti d'impiego

Temperatura liquido: da -10 °C a +90 °C.
Temperatura ambiente fino a 40 °C.
Altezza di aspirazione manometrica fino a 7 m.
Pressione finale massima ammessa nel corpo pompa : 10 bar.
Servizio continuo.

Motore

Motore ad induzione a 2 poli, 50 Hz (n ≈ 2900 1/min).

NR: trifase 230/400 V ± 10%, fino a 3 kW;
400/690 V ± 10%, da 4 a 18,5 kW.

NRM: monofase 230 V ± 10%.

Motore ad induzione a 4 poli, 50 Hz (n = 1450 1/min).

NR4: trifase 230/400 V ± 10%, fino a 3 kW;
400/690 V ± 10%, per 4 kW.

NR4M: monofase 230 V ± 10%.

Isolamento classe F. Protezione IP 54.

Motore predisposto per funzionamento con inverter da 0,75 kW per NR4 e 1,1 kW per NR.

Classe efficienza IE3 per motori trifasi da 0,75 kW.

Esecuzione secondo EN 60034-1; EN 60034-30-1.
EN 60335-1, EN 60335-2-41.

Campo di applicazione

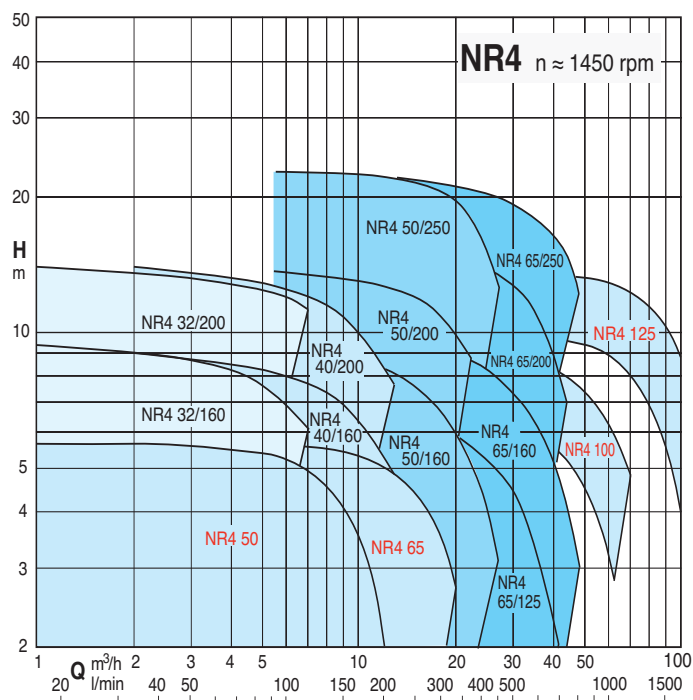
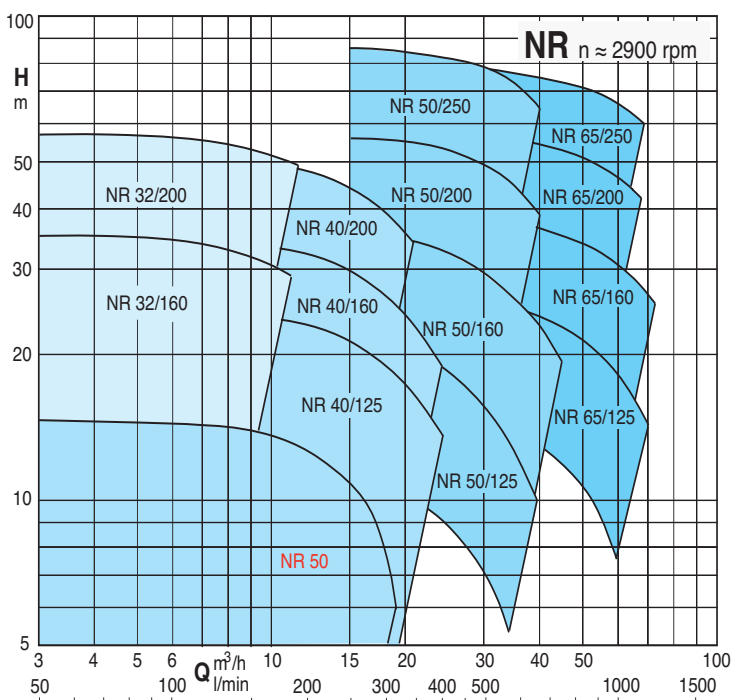

Pompe a velocità variabile

Le pompe **NR EI**, **NR4 EI** sono disponibili con potenze da 0,25 kW a 18,5 kW e sono dotate di inverter **I-MAT** a bordo.

Consentono di realizzare un sistema a velocità variabile estremamente compatto e efficiente, ideale nelle applicazioni di approvvigionamento idrico e nella distribuzione di acqua calda e fredda.

La elettropompa è fornita di trasduttori idonei alla modalità di funzionamento scelta dal cliente e programmata direttamente in fabbrica.

Vantaggi

- Risparmio energetico.
- Maggiore compattezza del sistema.
- Facilità di utilizzo.
- Programmazione personalizzata in base alle esigenze dell'impianto.
- Affidabilità.

Costruzione

Il sistema è composto da:

- Pompa
- Motore elettrico
- Variatore di frequenza I-MAT
- Adattatore per il montaggio a bordo motore
- Cavo di connessione tra inverter ed elettropompa
- Trasduttori

Caratteristiche principali

Potenza nominale motore da 0,25 kW a 18,5 kW

Campo di regolazione giri 1750÷2900 1/min (pompe 2 poli).

Campo di regolazione giri 870÷1450 1/min (pompe 4 poli).

Protezione contro il funzionamento a secco

Protezione contro il funzionamento a bocca chiusa

Protezione contro le perdite dell'impianto

Protezione contro le sovracorrenti nel motore

Protezione contro sovratensioni o sottotensioni nella rete di alimentazione

Protezione contro gli squilibri tra le fasi di alimentazione



Modalità di funzionamento



Modalità a pressione costante

con sensore di pressione

In questa modalità il sistema mantiene costante la pressione prestabilita al variare della portata richiesta dall'impianto.

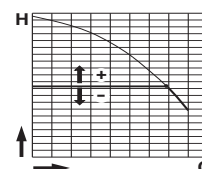

Modalità a pressione proporzionale

con sensore di pressione

In questa modalità il sistema varia la pressione di funzionamento in funzione della portata richiesta.

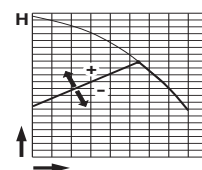

Modalità portata costante

con misuratore di portata

In questa modalità il sistema mantiene costante il valore di portata in un punto dell'impianto in funzione della pressione richiesta.

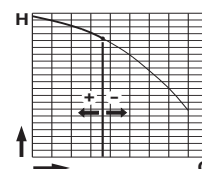

Modalità a velocità fissa

con impostazione della velocità preferenziale di rotazione.

In questa modalità, variando la frequenza di lavoro, si può scegliere una qualsiasi curva di utilizzo compresa all'interno del campo di lavoro.

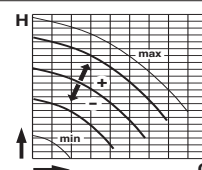

Modalità temperatura costante

con sensore di temperatura

In questo modo il sistema mantiene costante la temperatura in un punto del sistema modificando la velocità della pompa.

Curve caratteristiche $n \approx 2900$ 1/min

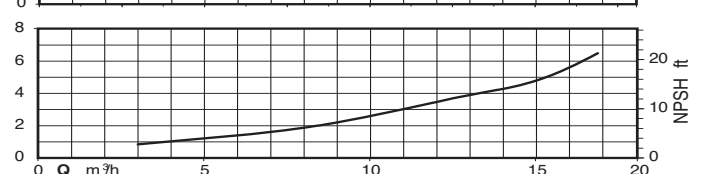
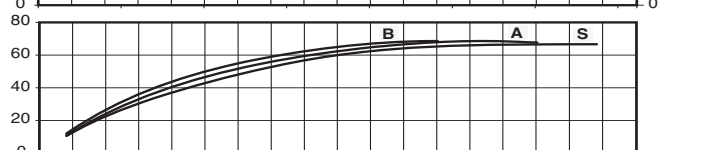
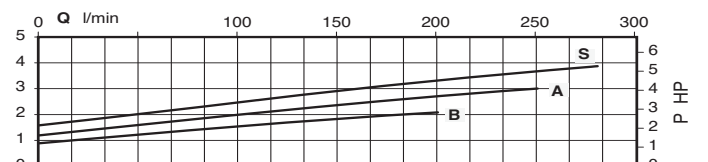
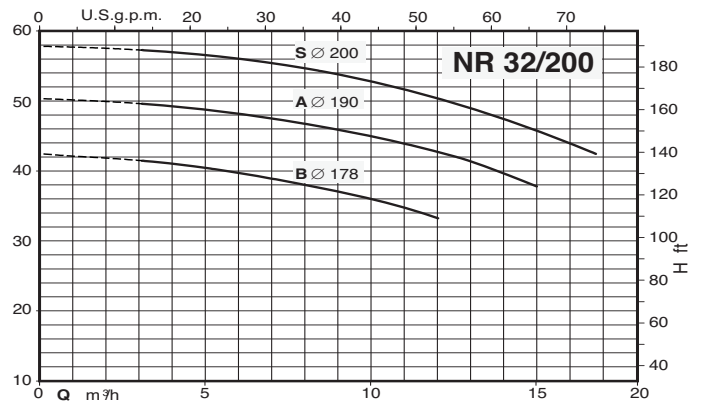
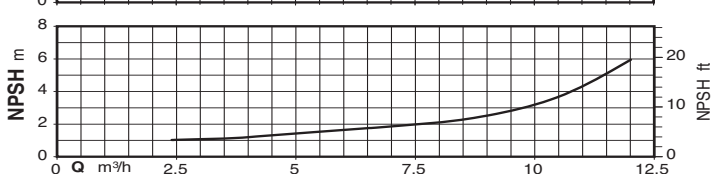
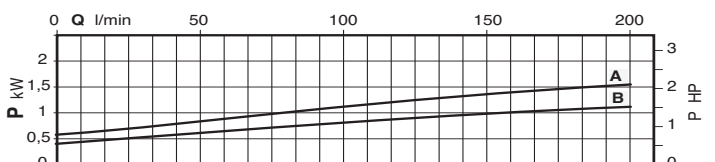
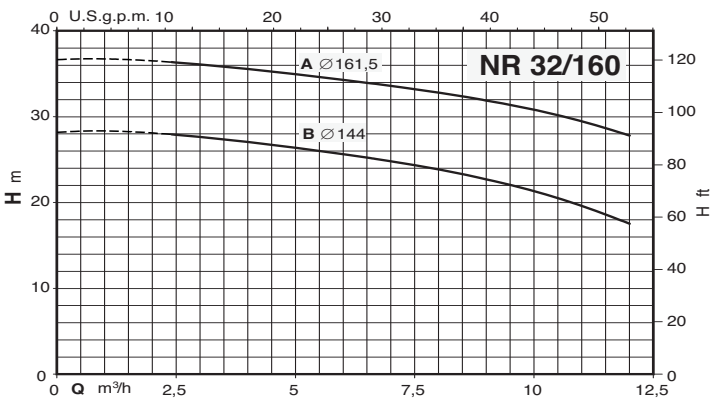
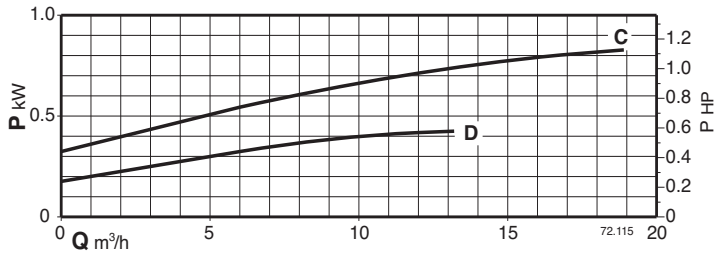
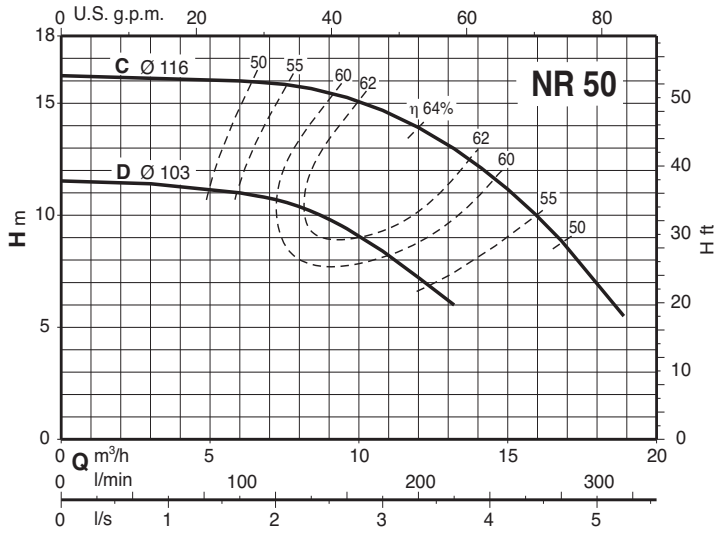

Curve caratteristiche $n \approx 2900$ 1/min

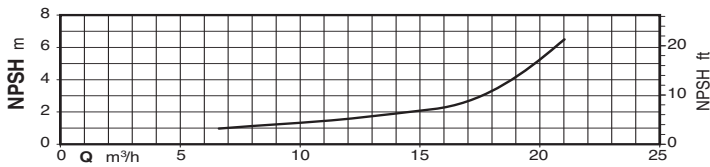
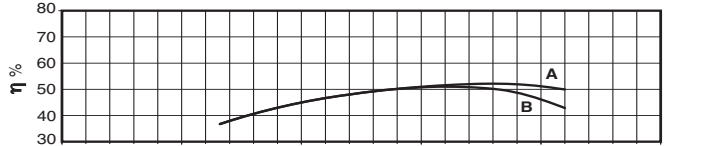
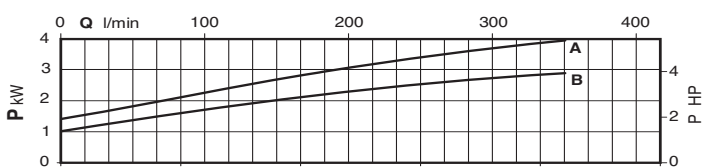
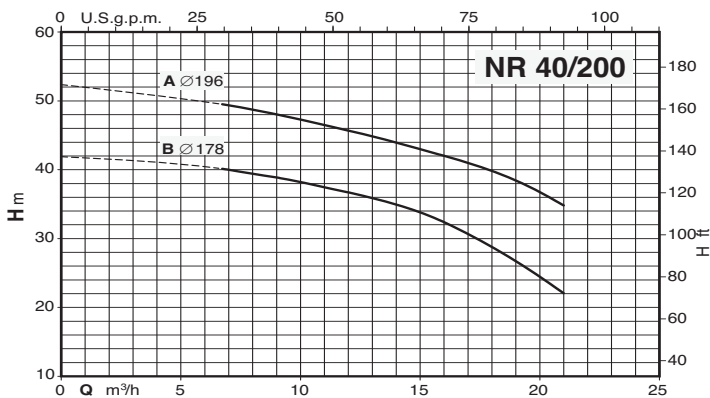
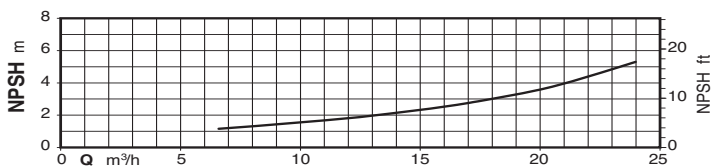
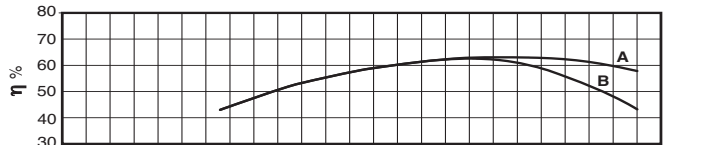
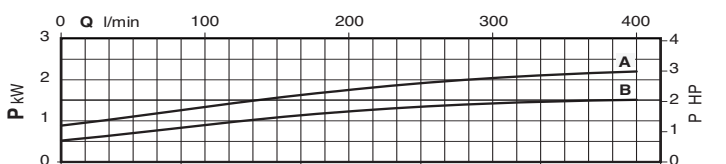
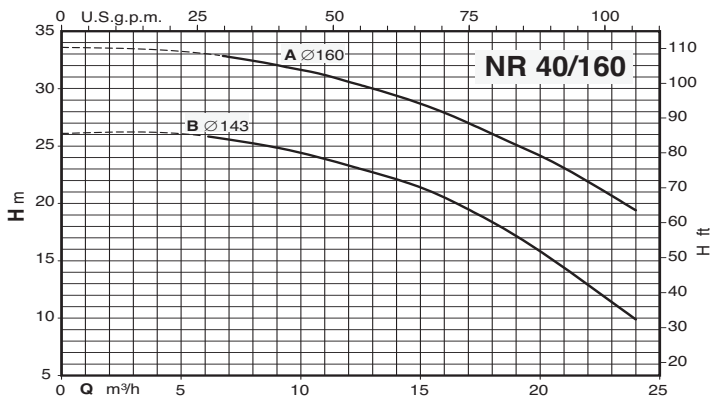
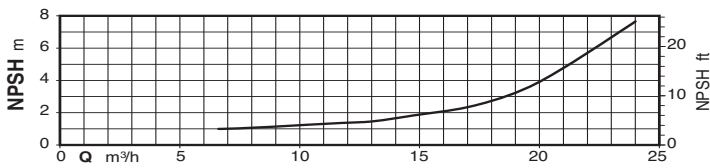
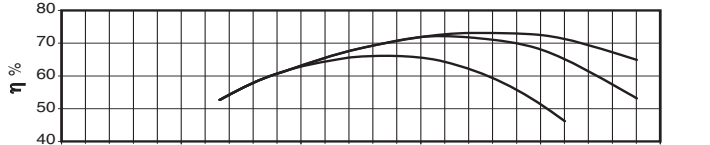
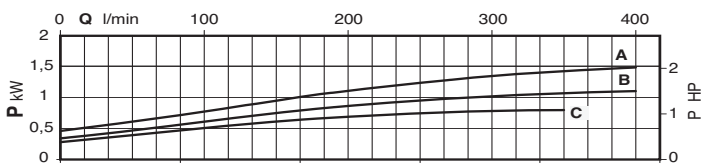
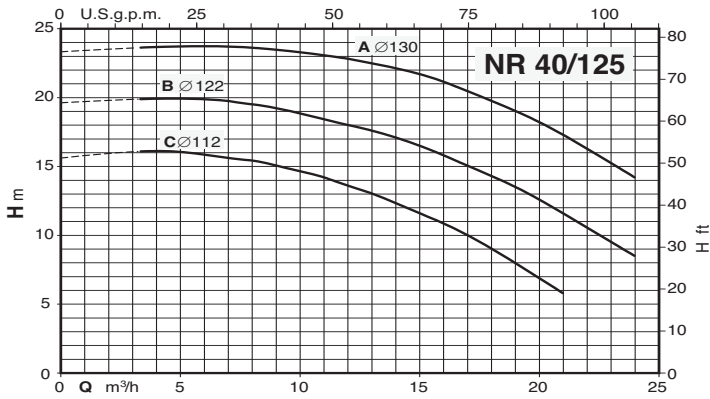

Curve caratteristiche $n \approx 2900$ 1/min

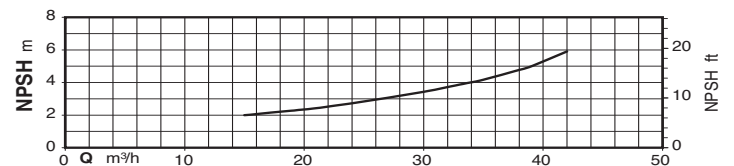
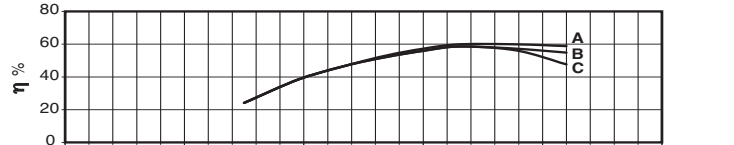
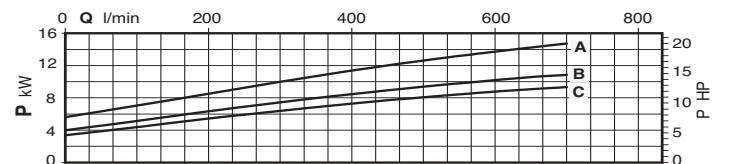
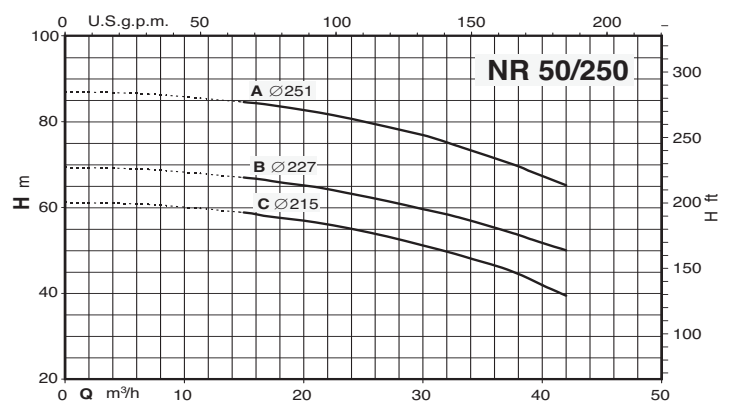
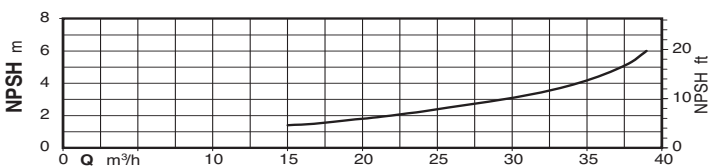
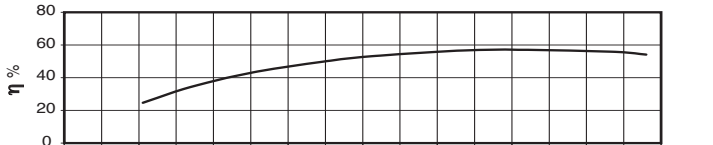
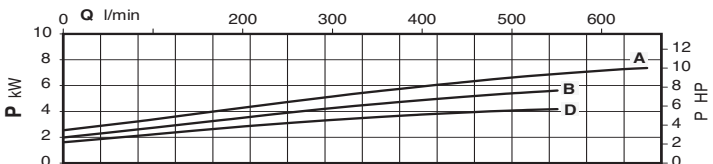
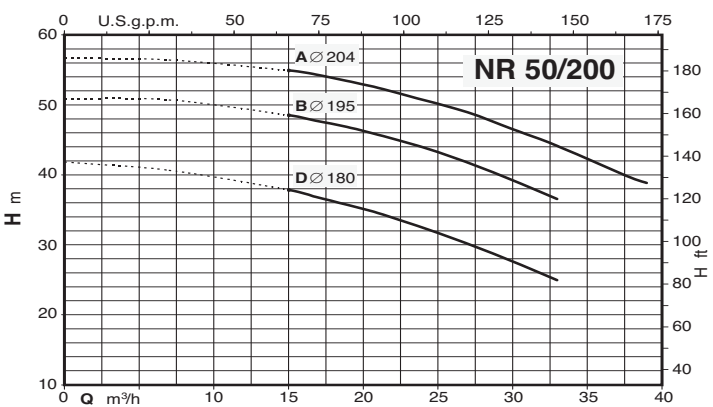
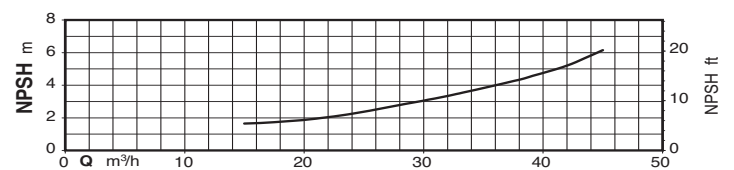
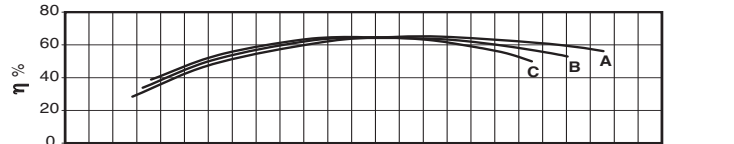
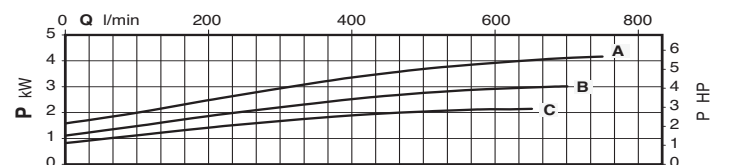
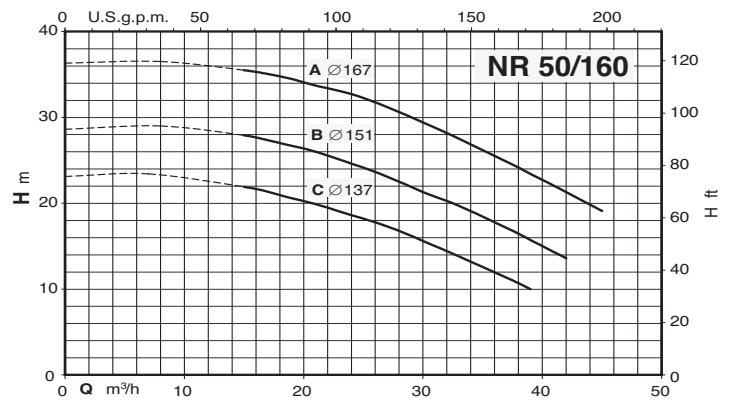
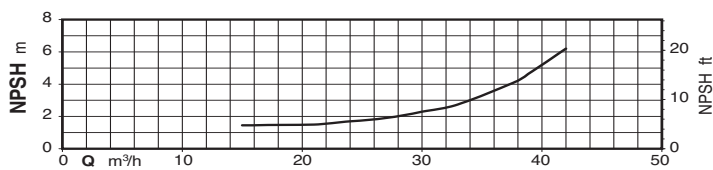
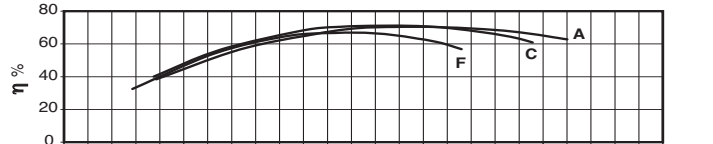
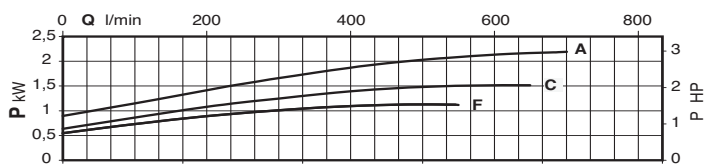
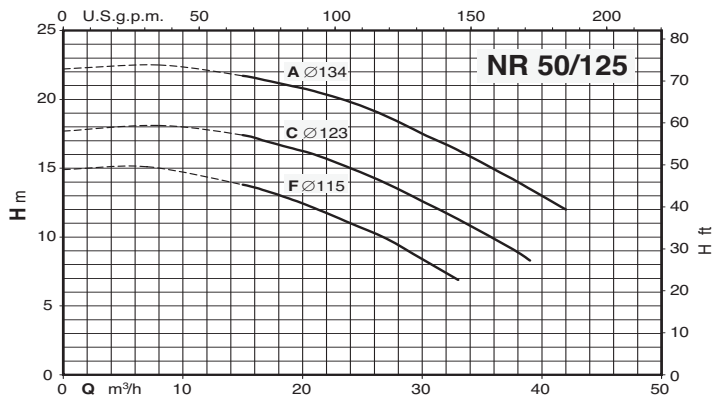

Curve caratteristiche $n \approx 2900$ 1/min

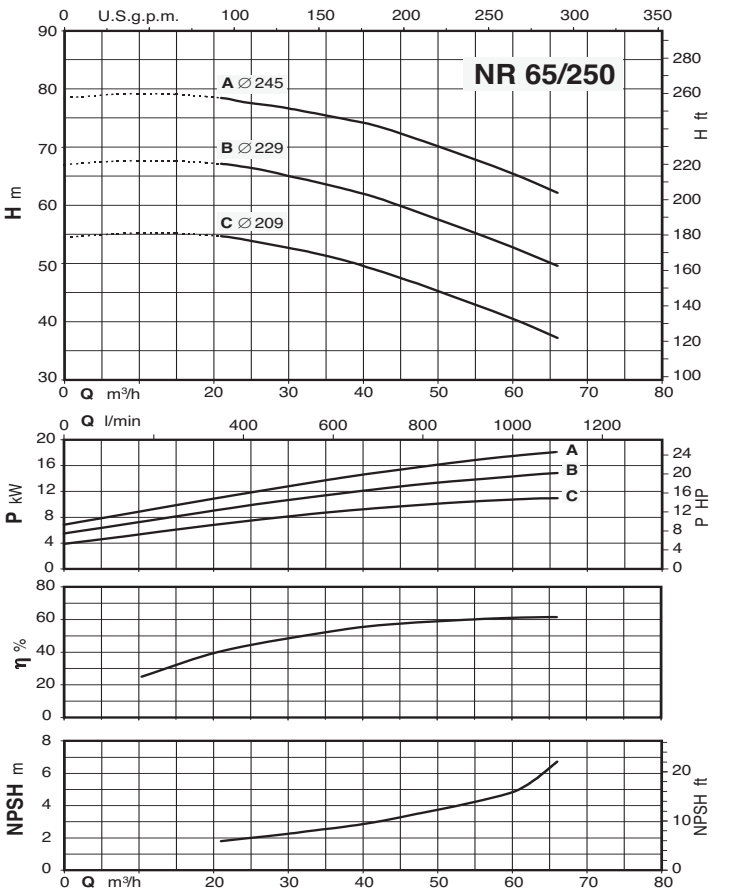
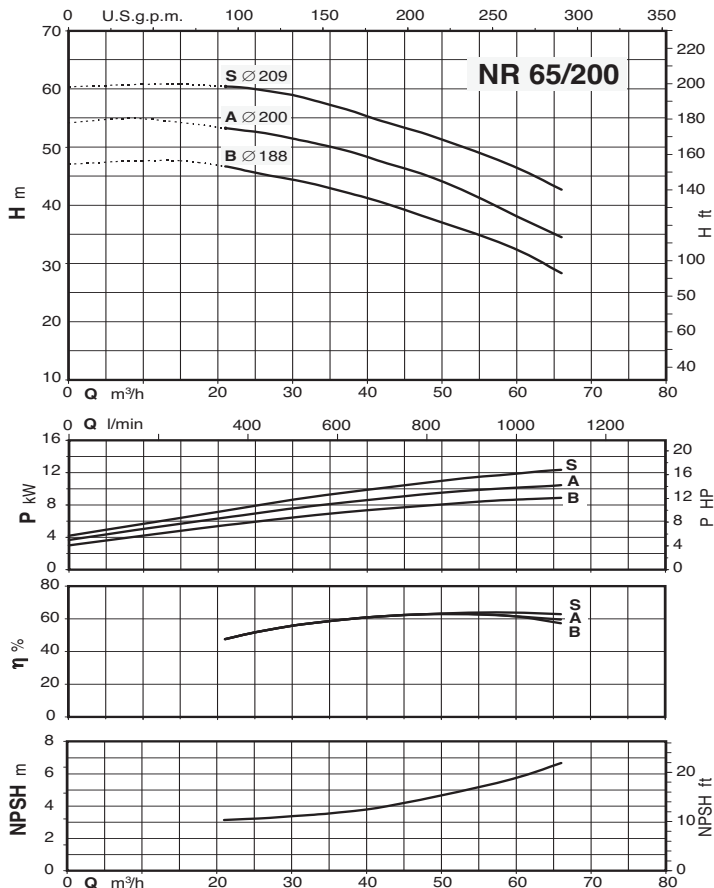
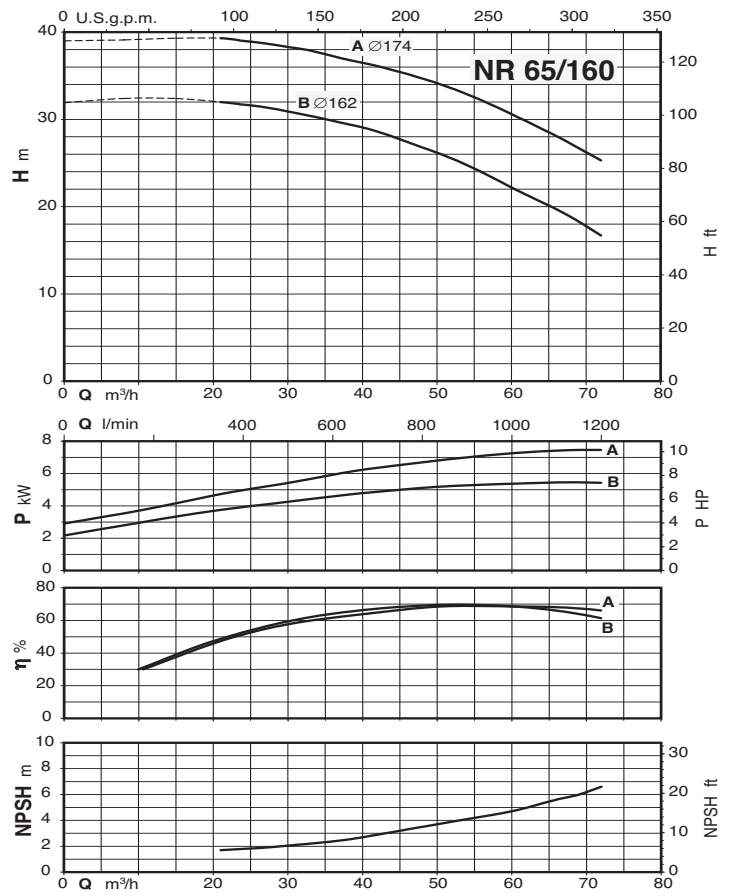
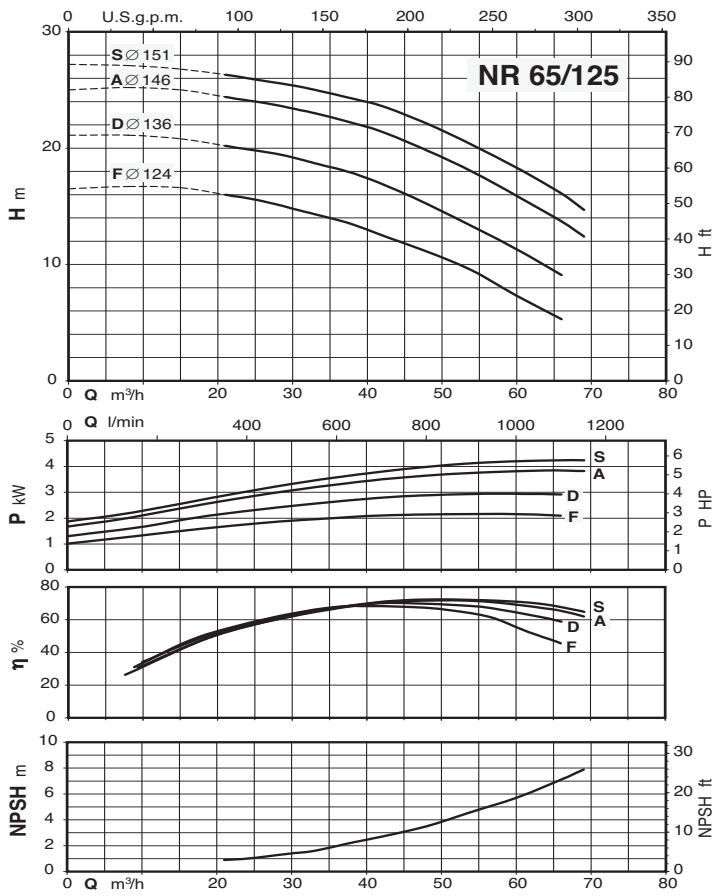

Curve caratteristiche $n \approx 1450$ 1/min

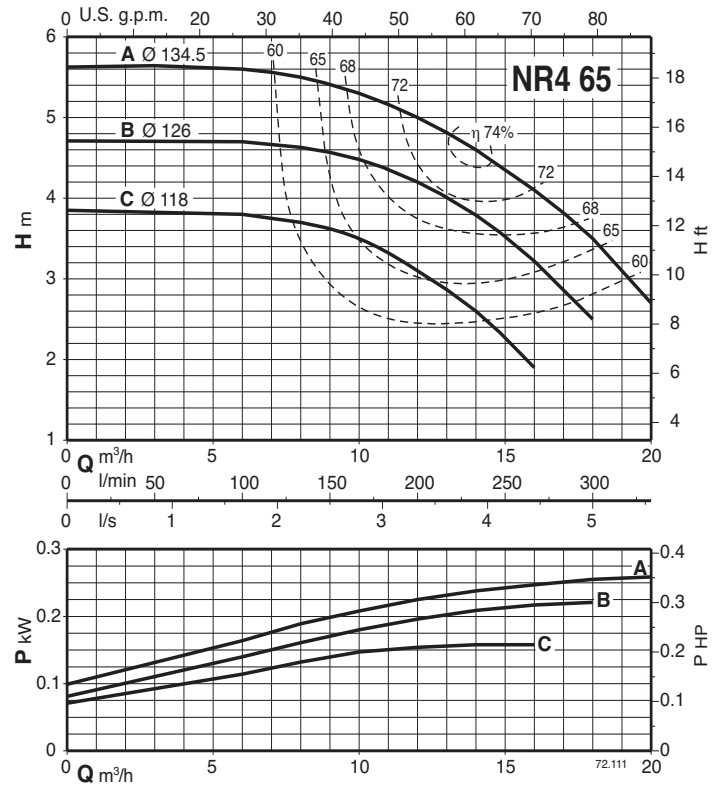
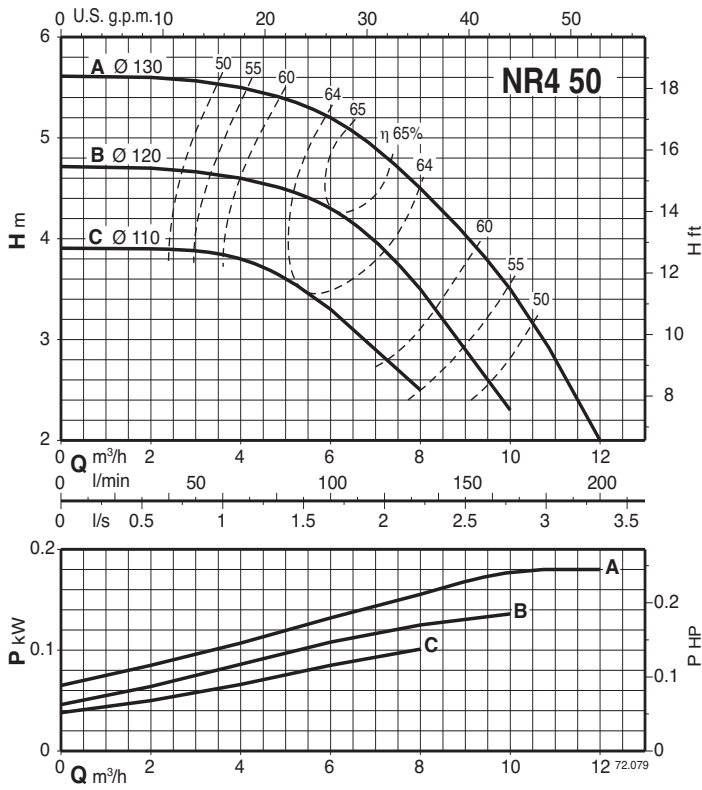

Curve caratteristiche $n \approx 1450$ 1/min

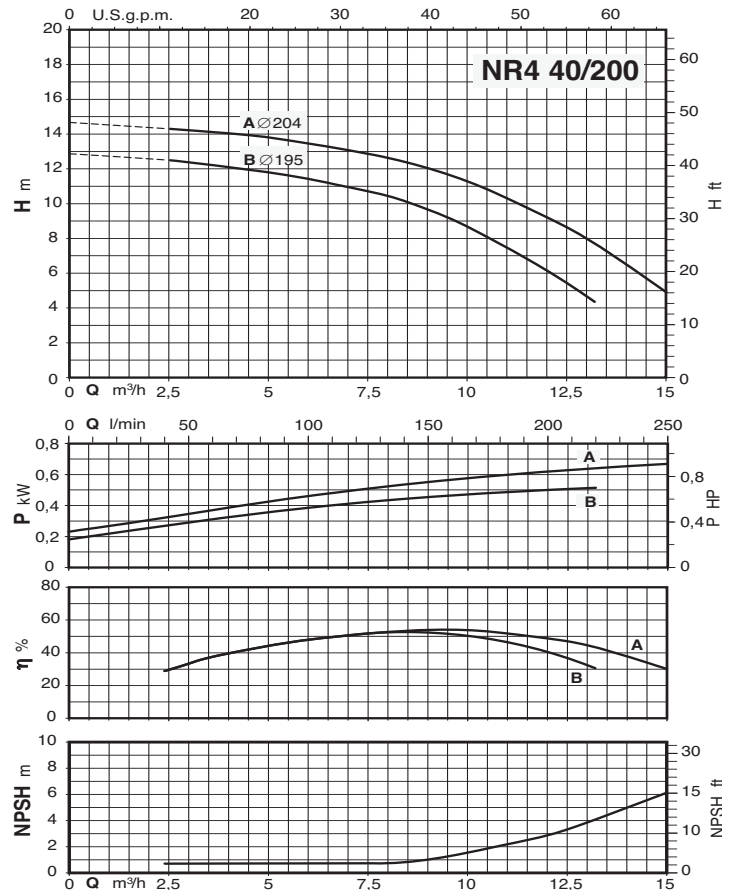
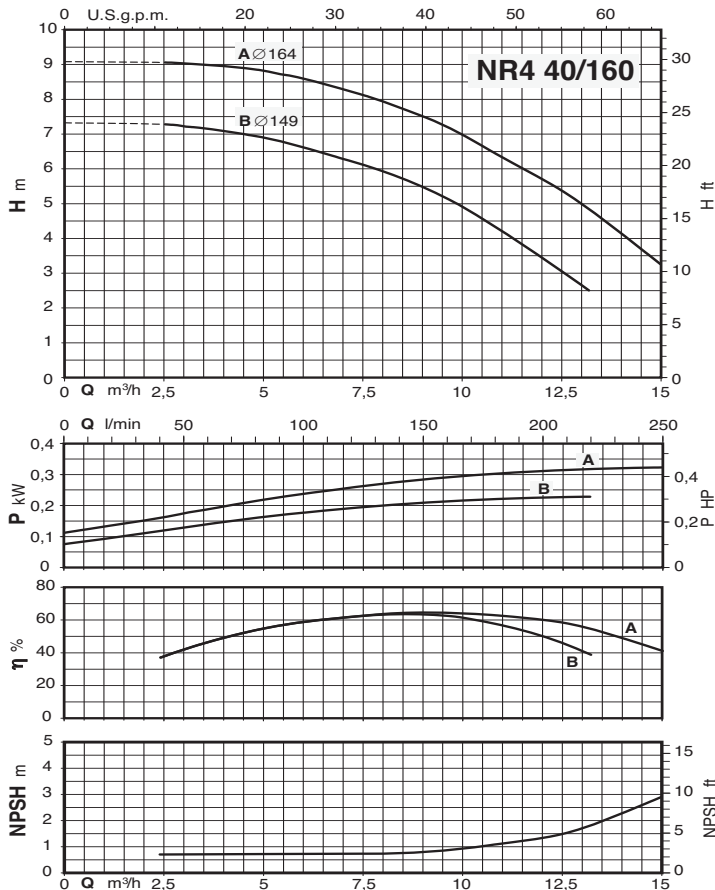
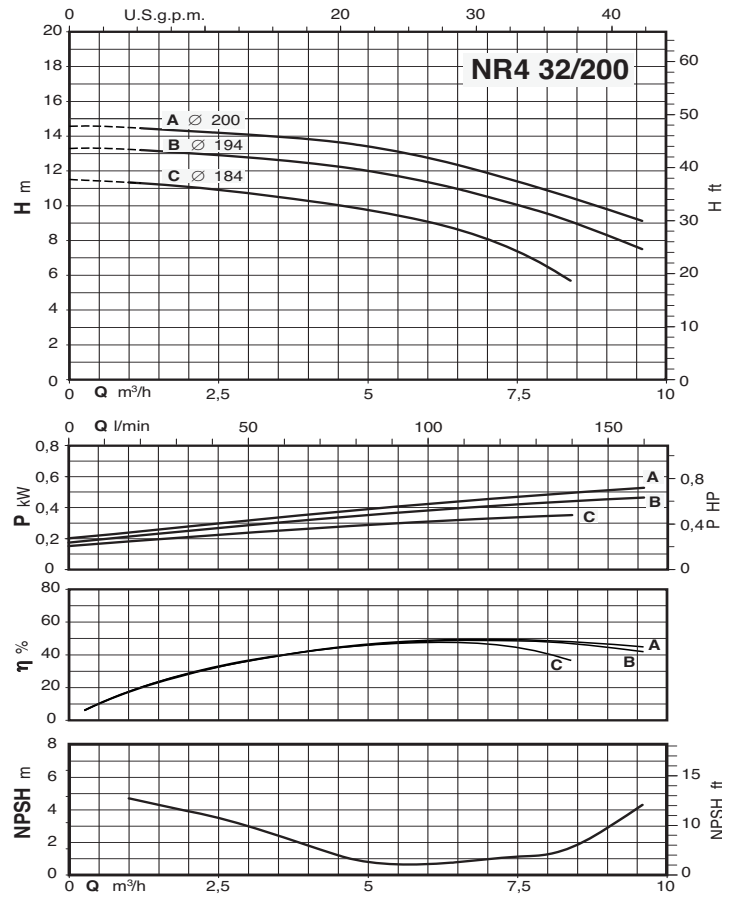
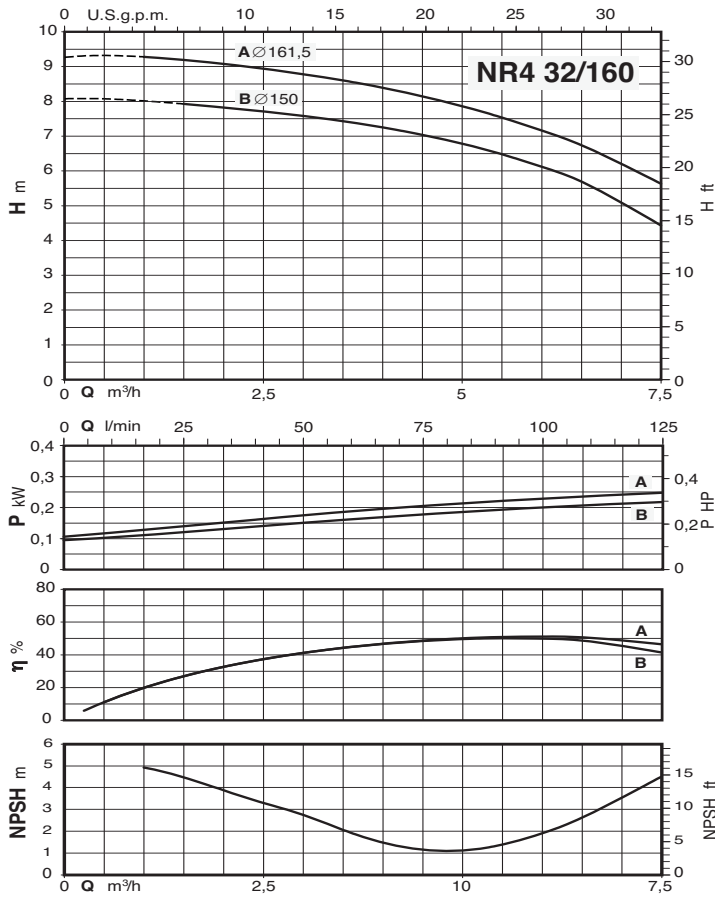

Curve caratteristiche $n \approx 1450$ 1/min

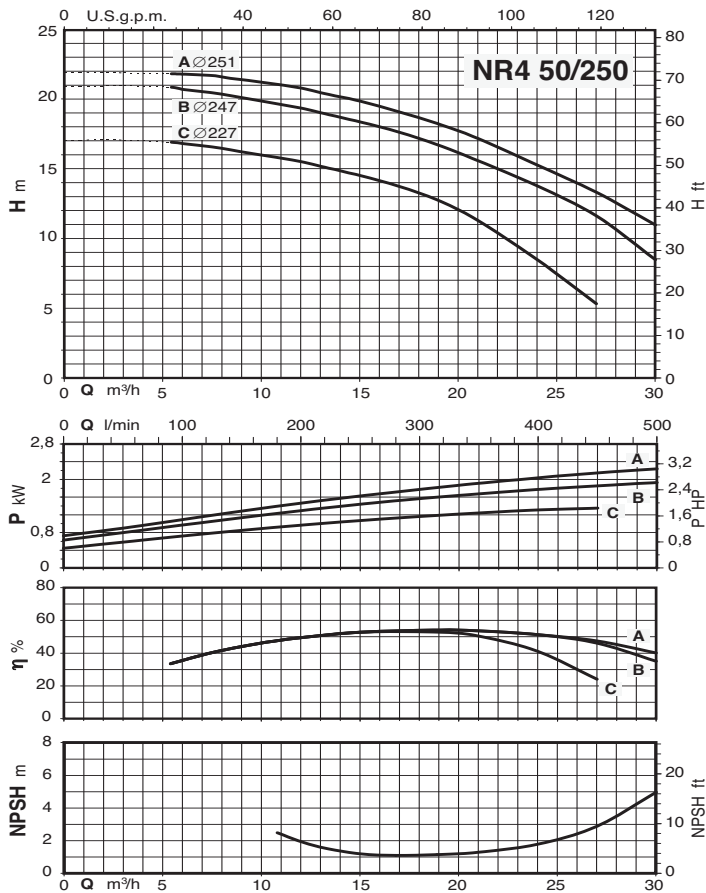
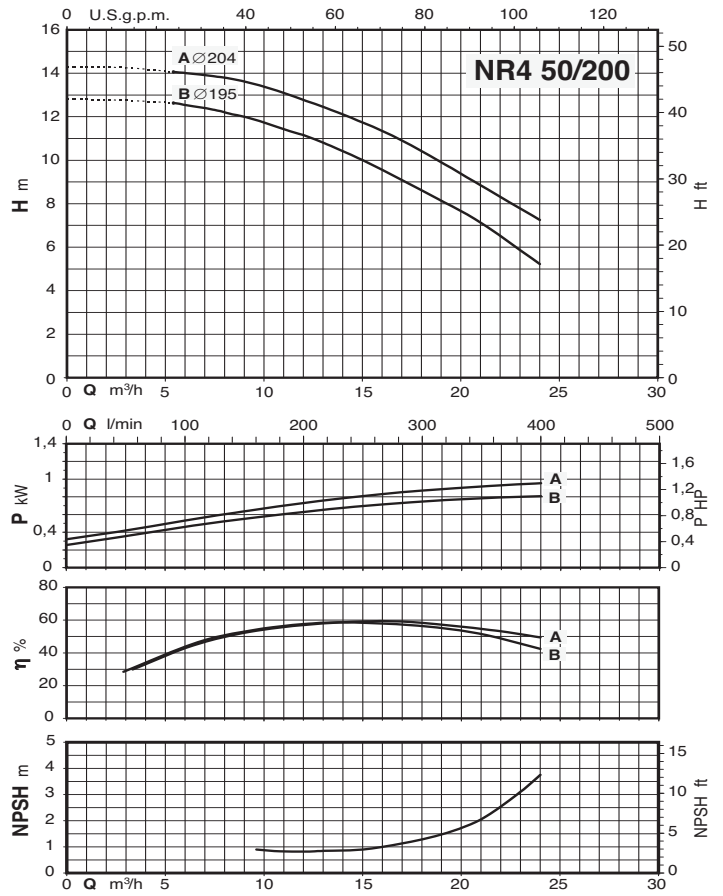
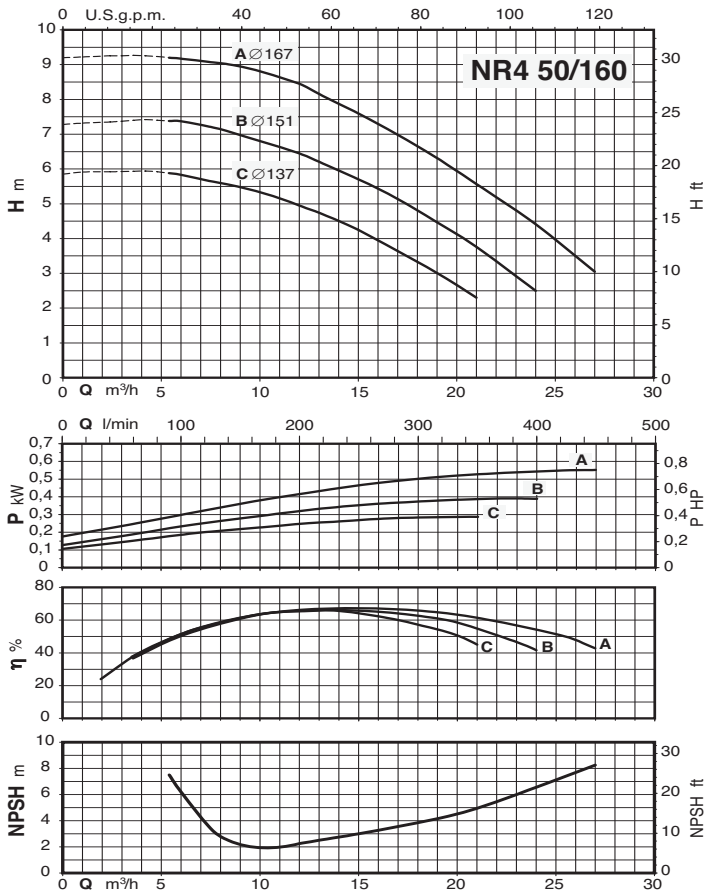

Curve caratteristiche $n \approx 1450$ 1/min

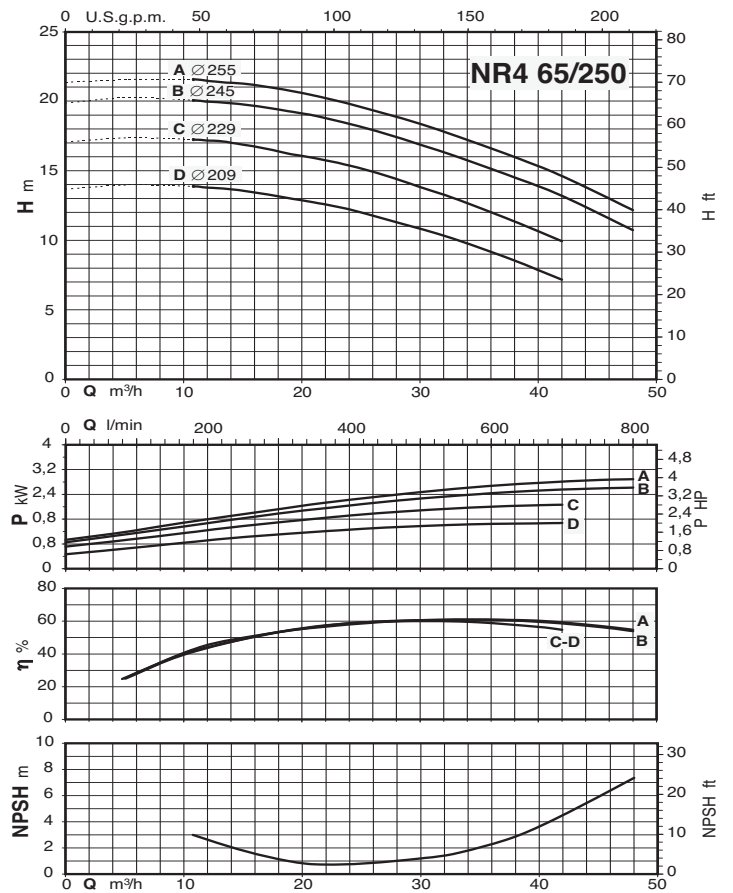
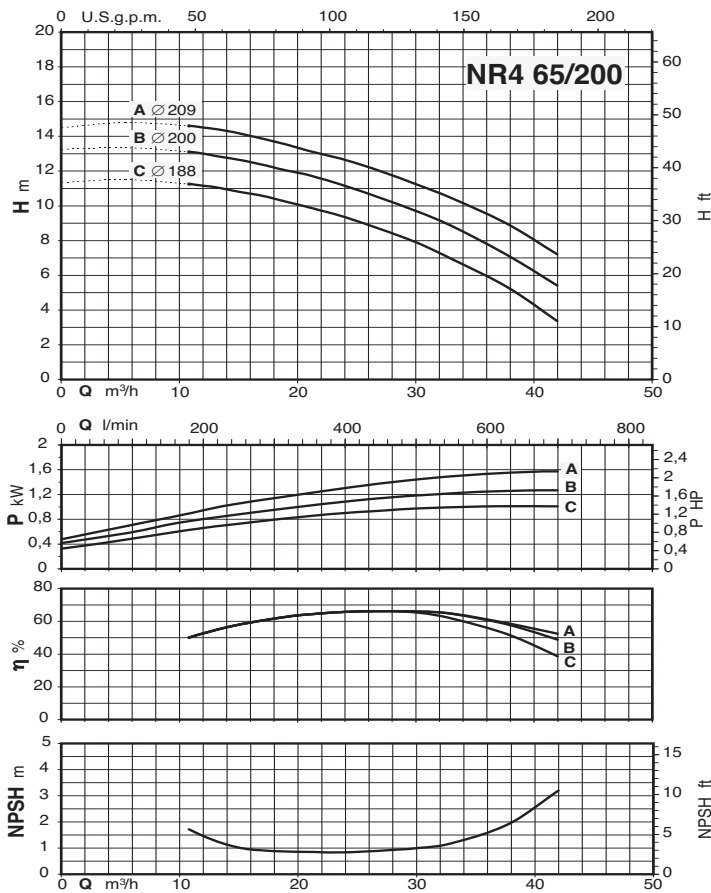
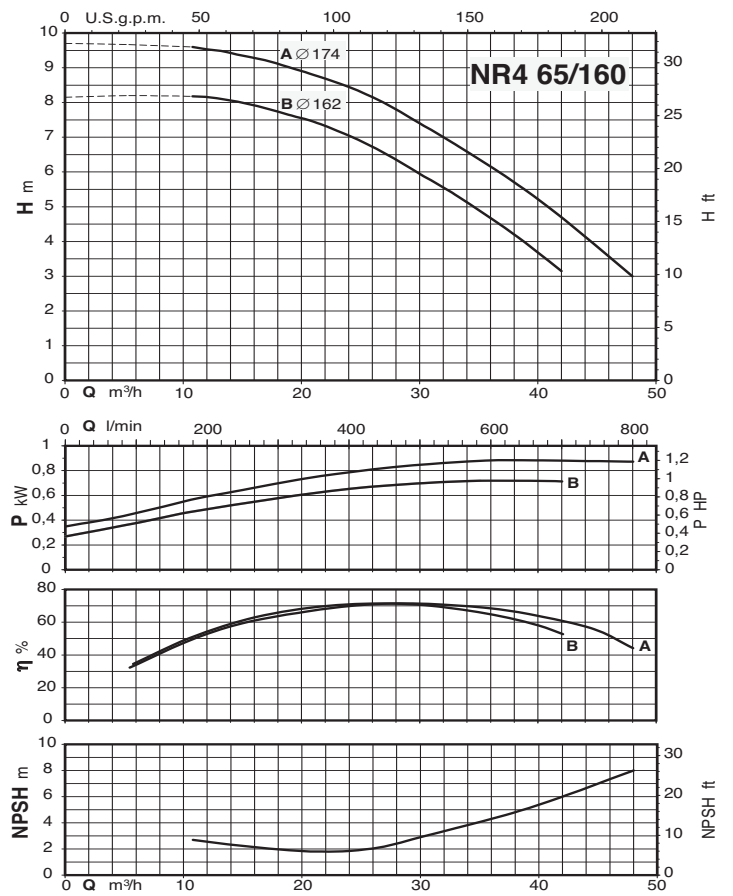
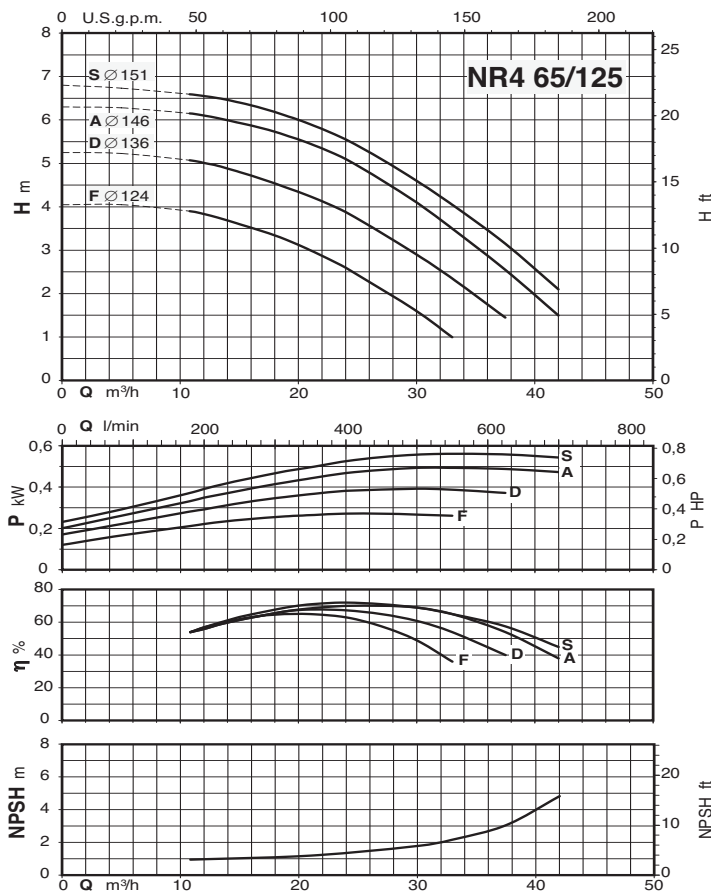

Curve caratteristiche $n \approx 1450$ 1/min

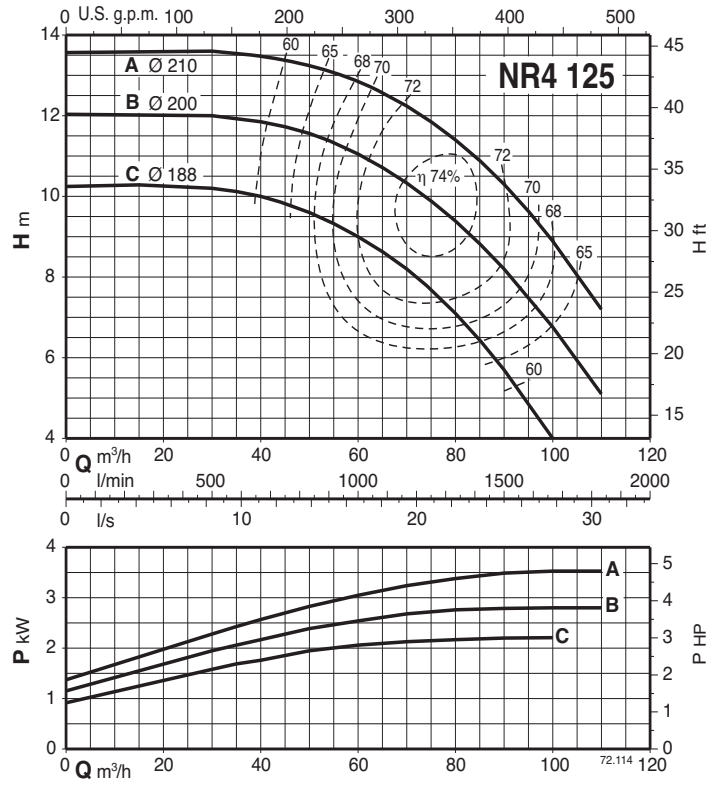
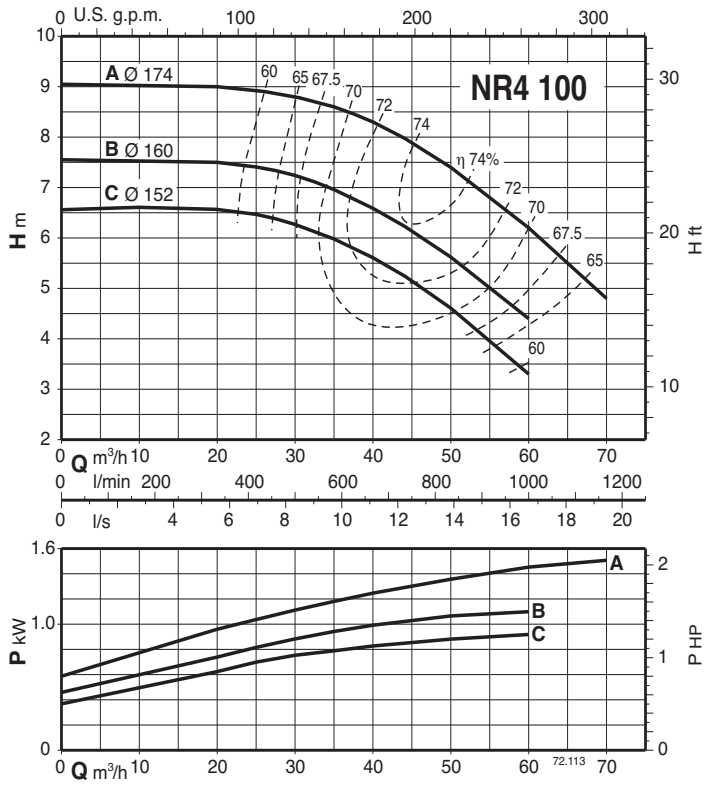

Dimensioni e pesi

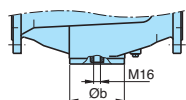
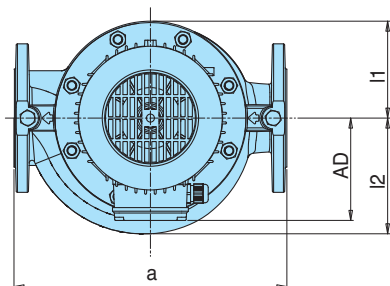
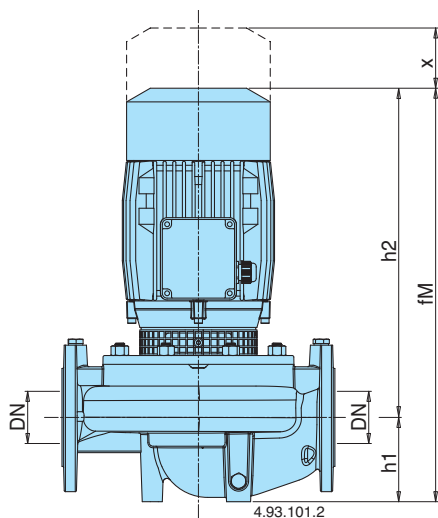

Flange PN 10, EN 1092-2

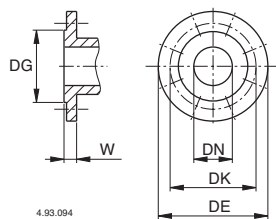

DN	mm					
	DG	DK	DE	Fori N°	Ø	W
32	76	100	140	4	19	18
40	84	110	150	4	19	18
50	99	125	165	4	19	20
65	118	145	185	4	19	20
80	132	160	200	8	19	22
100	156	180	220	8	19	24
125	184	210	250	8	19	24

TIPO	mm										kg
	DN	a	fM	h1	h2	Øb	AD	l1	l2	x	
NR 50D/A-C/B	50	320	360	90	270	98	111	93	100	70	21,7-23,8
NR 32/160A/A-B/A	32	340	421	80	341	-	128	102	102	60	28,6-27
NR 32/200B	32	440	469	85	384	-	128	126	126	60	36,3
NR 32/200A/A-S/A	32	440	495	85	410	-	138	126	126	60	44-47
NR 40/125A/A-B/A-C	40	320	420	81	339	-	128	93	98	70	29,5-27,5-26,5
NR 40/160B/A	40	320	430	81	349	-	128	119	119	75	35,0
NR 40/160A/A	40	320	470	81	389	-	128	119	119	75	40,0
NR 40/200A/A-B	40	440	496	81	430	-	138	140	140	75	56,6-53,4
NR 50/125C/A-F/A	50	340	437	90	347	-	128	96	115	75	31,5-29,5
NR 50/125A/B	50	340	477	90	387	-	128	96	115	75	36,1
NR 50/160C/B	50	340	480	90	390	-	128	120	128	75	41,6
NR 50/160A/B-B/A	50	340	506	90	416	-	138	120	128	75	51,8-48,5
NR 50/200D/B	50	440	516	100	416	-	138	140	140	80	59,7
NR 50/200A/A-B/A	50	440	544	100	444	-	160	140	140	80	77,2-69,7
NR 50/250C/B	50	440	657	100	557	-	185	175	175	85	114
NR 50/250B/B	50	440	707	100	557	-	185	175	175	85	121
NR 50/250A/B	50	440	732	100	632	-	185	175	175	85	149,5
NR 65/125F/B	65	340	494	105	389	-	128	121	145	95	46
NR 65/125S/B-A/B-D/A	65	340	520	105	415	-	138	121	145	95	56,1-56,1-54,6
NR 65/160A/A-B/A	65	340	552	105	447	-	160	121	142	95	74-67,5
NR 65/200B/B	65	475	666	105	561	-	185	140	153	90	108
NR 65/200A/B	65	475	716	105	611	-	185	140	153	90	114
NR 65/200S/B	65	475	741	105	636	-	185	140	153	90	142,5
NR 65/250C/B	65	475	722	105	567	-	185	175	175	90	134
NR 65/250A/B-B/B	65	475	747	105	642	-	185	175	175	90	161-155

TIPO	mm										kg
	DN	a	fM	h1	h2	Øb	AD	l1	l2	x	
NR4 50A/A-B/A-C/A	50	320	360	90	270	98	111	93	100	70	22-22-22
NR4 65A/A-B/A-C/A	65	360	370	100	270	118	111	102	114	70	28-28-28
NR4 100A/B-B/B-C/B	100	500	549	150	399	162	138	153	173	105	67-59-59
NR4 125C/B	125	600	589	170	419	194	138	172	195	120	91,5
NR4 125A/A-B/A	125	600	608	160	438	194	160	172	195	120	110-108
NR4 32/160A-B	32	340	421	80	341	-	128	102	102	60	23-22,9
NR4 32/200B-C	32	440	429	85	344	-	128	126	126	60	30,8-29,2
NR4 32/200A/A	32	440	469	85	344	-	128	126	126	60	
NR4 40/160A-B	40	320	430	81	349	-	128	119	119	75	31,5 - 31
NR4 40/200B	40	440	430	81	349	-	128	140	140	75	39,5
NR4 40/200A/A	50	440	470	81	349	-	128	140	140	75	43
NR4 50/160B-C	50	340	440	90	350	-	128	120	128	75	35,5-33,5
NR4 50/160A/B	50	340	480	90	350	-	128	120	128	75	37,5
NR4 50/200A/B-B/B	50	440	516	100	416	-	138	140	140	80	56
NR4 50/250C/B	50	440	516	100	416	-	138	175	175	85	77,5
NR4 50/250A/A-B/B	50	440	545	100	445	-	160	175	175	85	93,5-80
NR4 65/125D-F	65	340	454	105	349	-	128	121	145	95	39-37
NR4 65/125S/B-A/B	65	340	494	105	349	-	128	121	145	95	42-41,5
NR4 65/160A/B-B/B	65	340	504	105	399	-	138	121	142	95	42,7-42,5
NR4 65/200C/B	65	475	536	105	431	-	138	140	153	90	52
NR4 65/200B/B	65	475	536	105	431	-	138	140	153	90	60
NR4 65/200A/B	65	475	552	105	447	-	160	140	153	90	64,5
NR4 65/250C/B-D/B	65	475	555	105	450	-	160	175	175	90	75,5-75,5
NR4 65/250A/A-B/A	65	475	555	105	450	-	160	175	175	90	98-85

Installazione

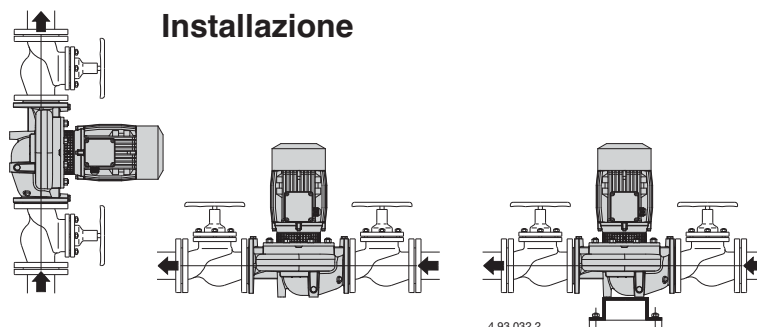

Dimensioni e pesi

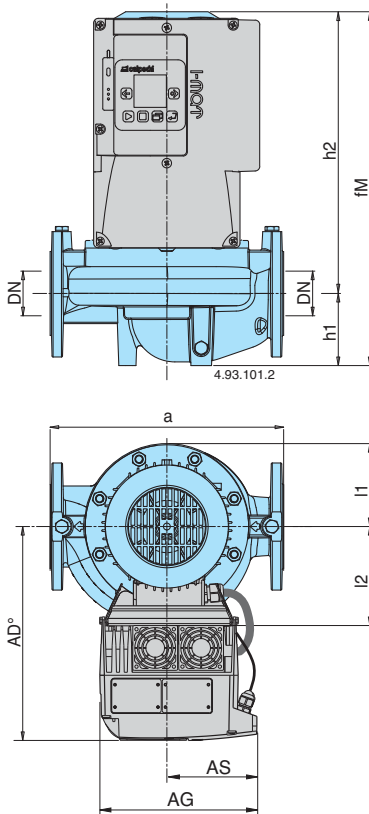

Flange PN 10, EN 1092-2

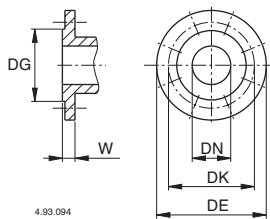

DN	mm					
	DG	DK	DE	Fori		W
				N°	Ø	
32	76	100	140	4	19	18
40	84	110	150	4	19	18
50	99	125	165	4	19	20
65	118	145	185	4	19	20
80	132	160	200	8	19	22
100	156	180	220	8	19	24
125	184	210	250	8	19	24

TIPO	mm											kg
	DN	a	fM	h1	h2	AD°	AG	AS	l1	l2	x	
NR EI 50D/A-C/B	50	320	399	90	270	270	190	105	93	100	70	28-30,2
NR EI 32/160A/A-B/A	32	340	421	80	341	286	190	105	102	102	60	35-33,3
NR EI 32/200B	32	440	469	85	384	286	210	118	126	126	60	43,8
NR EI 32/200A/A-S/A	32	440	495	85	410	294	210	118	126	126	60	51,5-54,5
NR EI 40/125A/A-B/A-C	40	320	420	81	339	286	190	105	93	98	70	35,9-33,9-32,9
NR EI 40/160B/A	40	320	430	81	349	286	190	105	119	119	75	41,4
NR EI 40/160A/A	40	320	470	81	389	286	210	118	119	119	75	47,5
NR EI 40/200A/A-B	40	440	496	81	430	294	210	118	140	140	75	64,1-61
NR EI 50/125C/A-F/A	50	340	437	90	347	286	190	105	96	115	75	37,9-35,9
NR EI 50/125A/B	50	340	477	90	387	286	210	118	96	115	75	43,6
NR EI 50/160C/B	50	340	480	90	390	286	210	118	120	128	75	49,1
NR EI 50/160A/B-B/A	50	340	506	90	416	294	210	118	120	128	75	59,3-56
NR EI 50/200D/B	50	440	516	100	416	294	210	118	140	140	80	67,2
NR EI 50/200A/A-B/A	50	440	544	100	444	368	281	153	140	140	80	92-84,5
NR EI 50/250C/B	50	440	657	100	557	393	281	153	175	175	85	128,8
NR EI 50/250B/B	50	440	707	100	557	393	281	153	175	175	85	135,8
NR EI 50/250A/B	50	440	732	100	632	471	350	190	175	175	85	184,5
NR EI 65/125F/B	65	340	494	105	389	286	210	118	121	145	95	53,5
NR EI 65/125S/B-A/B-D/A	65	340	520	105	415	294	210	118	121	145	95	63,6-63,6-62,1
NR EI 65/160A/A-B/A	65	340	552	105	447	368	281	153	121	142	95	88,8-82,3
NR EI 65/200B/B	65	475	666	105	561	368	281	153	140	153	90	122,8
NR EI 65/200A/B	65	475	716	105	611	393	281	153	140	153	90	128,8
NR EI 65/200S/B	65	475	741	105	636	471	350	190	140	153	90	177,5
NR EI 65/250C/B	65	475	722	105	567	393	281	153	175	175	90	148,8
NR EI 65/250A/B-B/B	65	475	747	105	642	471	350	190	175	175	90	196-190

TIPO	mm											kg
	DN	a	fM	h1	h2	AD°	AG	AS	l1	l2	x	
NR4 EI 50A/A-B/A-C/A	50	320	399	90	270	270	190	105	93	100	70	28,4-28,4-28,4
NR4 EI 65A/A-B/A-C/A	65	360	409	100	270	270	190	105	102	114	70	34,4-34,4-34,4
NR4 EI 100B/B-C/B	100	500	549	150	399	294	190	105	153	173	105	65,4-65,4
NR4 EI 100A/B	100	500	549	150	399	294	190	105	153	173	105	73,4
NR4 EI 125A/A-B/A-C/B	125	600	608	160	438	368	210	118	172	195	120	117,5-115,5-97,9
NR4 EI 32/160A-B	32	340	421	80	341	286	190	105	102	102	60	29,4-29,3
NR4 EI 32/200B-C	32	440	429	85	344	286	190	105	126	126	60	37,2-35,2
NR4 EI 32/200A/A	32	440	469	85	344	286	190	105	126	126	60	
NR4 EI 40/160A-B	40	320	430	81	349	286	190	105	119	119	75	37,9-37,4
NR4 EI 40/200B	40	440	430	81	349	286	190	105	140	140	75	45,9
NR4 EI 40/200A/A	40	440	470	81	349	286	190	105	140	140	75	49,4
NR4 EI 50/160B-C	50	340	440	90	350	286	190	105	120	128	75	41,9-39,9
NR4 EI 50/160A/B	50	340	480	90	350	286	190	105	120	128	75	43,9
NR4 EI 50/200A/B-B/B	50	440	516	100	416	294	190	105	140	140	80	62,4
NR4 EI 50/250C/B	50	440	516	100	416	294	190	105	175	175	85	83,9
NR4 EI 50/250A/A-B/B	50	440	545	100	445	368	210	118	175	175	85	101-86,4
NR4 EI 65/125D-F	65	340	454	105	349	286	190	105	121	145	95	45,4-43,4
NR4 EI 65/125S/B-A/B	65	340	494	105	349	286	190	105	121	145	95	48,4-48
NR4 EI 65/160A/B-B/B	65	340	504	105	399	294	190	105	121	142	95	49,1-48,9
NR4 EI 65/200C/B	65	475	536	105	431	294	190	105	140	153	90	58,4
NR4 EI 65/200B/B	65	475	536	105	431	294	190	105	140	153	90	66,4
NR4 EI 65/200A/B	65	475	552	105	447	368	210	118	175	175	90	70,9
NR4 EI 65/250C/B-D/B	65	475	555	105	450	365	210	118	175	175	90	81,9-81,9
NR4 EI 65/250A/A-B/A	65	475	555	105	450	368	210	118	175	175	90	105,5-92,5

Caratteristiche costruttive**Una nuova compattezza**

Una struttura compatta che permette di installare con semplicità il prodotto anche in spazi ridotti.

Un esclusivo design

Una innovativa rete di protezione (brevettata) impedisce il contatto con parti in rotazione della pompa salvaguardando la sicurezza degli utenti e garantendo l'ispezionabilità della tenuta.

Una fluidodinamica esasperata

Lo studio fluidodinamico dell'accoppiamento tra girante e corpo pompa ha permesso di ridurre le perdite e quindi di incrementare i rendimenti delle pompe.

Massima silenziosità

Condotti del fluido tracciati per il minimo disagio acustico

Un'idraulica d'avanguardia

La geometria della girante è ottimizzata per ottenere il massimo rendimento e la migliore capacità di aspirazione.

